



CATALOGO GENERALE

Strutture Produttive



Camere bianche certificate classe ISO 7 e ISO 8 sorvegliate e validate in accordo con la EN ISO 14644-1.

Magazzini strutturati per lo stoccaggio di componenti.

Ambienti ventilati per l'ulteriore abbattimento di residuo Eto su prodotti finiti e sterili.

Ambienti a temperatura e umidità controllata per lo stoccaggio di prodotti finiti critici.



Indice

Pagina 2	Accessori
Pagina 4	Pompa Elastomerica
Pagina 5	Oncologici
Pagina 8	Multifunzione
Pagina 12	Drenaggi
Pagina 15	Irrigazione
Pagina 16	Linee estensione
Pagina 20	Infusione
Pagina 23	Nutrizione
Pagina 27	Catetere Intravenoso
Pagina 28	Ago Epicranico
Pagina 29	Cateteri Uretrali
Pagina 31	Medicazioni
Pagina 32	Ossigeno Terapia

CAPSULA CHIUSA PER RACCORDO LUER LOCK



 Confezionamento
Packaging

CONFEZIONI	N°Unità	BOX
10	100	1000

closed / chiuso
ABS

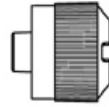

Descrizione	Codice
Capsula chiusa	ACC001

RACCORDO CHIUSO COMBI STOPPER



 Confezionamento
Packaging

CONFEZIONI	N°Unità	BOX
10	100	1000

closed / chiuso
HDPE

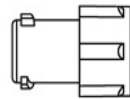

Descrizione	Codice
Raccordo combi	ACC002

RACCORDO APERTO COMBI



 Confezionamento
Packaging

CONFEZIONI	N°Unità	BOX
10	100	1000

open / aperto
HDPE

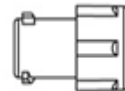

Descrizione	Codice
Raccordo aperto	ACC003

Labelling Key

Accessories

CE 0123

STERILE EO



Destroy
after use



RACCORDO PERFORABILE LUER LOCK



Confezionamento Packaging

CONFEZIONI	N°Unità	BOX
10	100	1000



Descrizione	Codice
Raccordo perforabile	ACC004

LATEX FREE HDPE

RUBINETTO



Confezionamento Packaging

CONFEZIONI	N°Unità	BOX
10	50	500

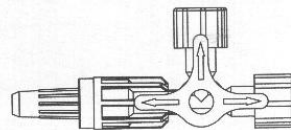

Descrizione	Codice
Rubicetto	ACC005

PC HDPE

RAMPA DI RUBINETTI

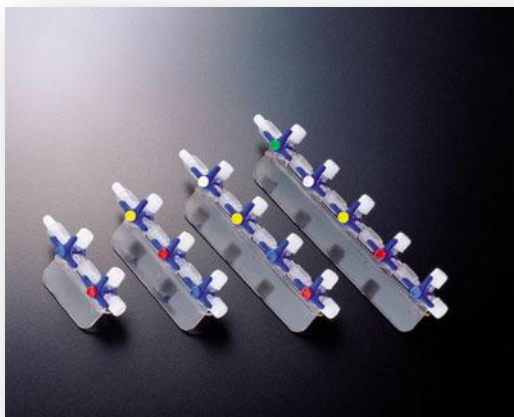

Confezionamento Packaging

CONFEZIONI	N°Unità	BOX
10	100	1000

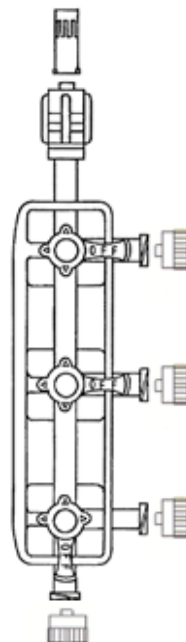

PC HDPE

Descrizione	Codice
Rampa 2 rubinetti	ACC006
Rampa 3 rubinetti	ACC007
Rampa 4 rubinetti	ACC008
Rampa 5 rubinetti	ACC009

Labelling Key

CE 0123 **STERILE EO** Destroy after use

Accessories

POMPA ELASTOMETRICA

Standard

POMPA ELASTOMETRICA

Con bolo (PCA) Patient Controlled Analgesia (analgesia controllata dal paziente).



	Confezionamento Packaging	
CONFEZIONI	N°Unità	BOX
10	10	10

CODICE	DESCRIZIONE	VOLUME ML.	FLUSSO ML/H
PET0103	Pompa a flusso continuo	60	2.0
PET0105	Pompa a flusso continuo	60	5.0
PET1003	Pompa a flusso continuo	100	2.0
PET1005	Pompa a flusso continuo	100	5.0
PET1751	Pompa a flusso continuo	275	5.0/6.0

CODICE	DESCRIZIONE	VOLUME ML.	FLUSSO ML/H
PET2001	Pompa a flusso variabile	100	2.0/3.0/4.0/5.0
PET2002	Pompa a flusso variabile	150	4.0/6.0/8.0/10
PET2003	Pompa a flusso variabile	200	4.0/6.0/8.0/10
PET2004	Pompa a flusso variabile	275	6.0/8.0/10 /12

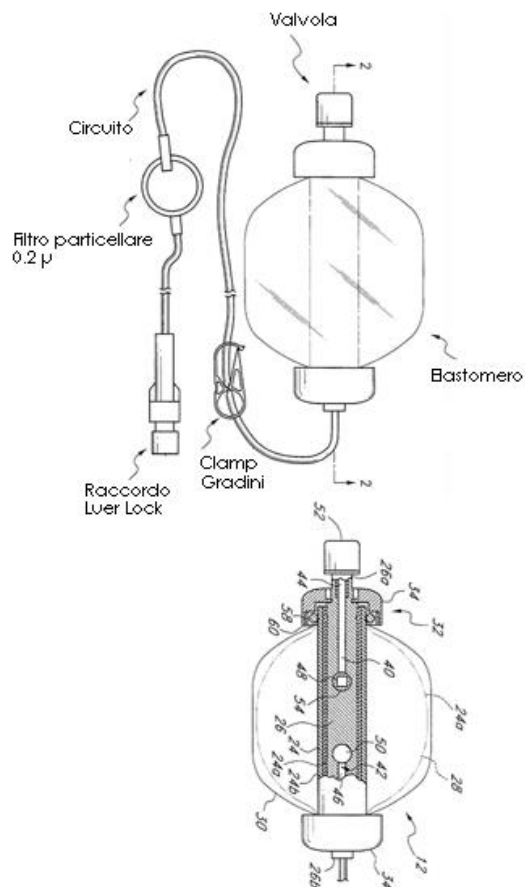

Labelling Key



ADATTATORE UNIVERSALE PER SET POMPA



	Confezionamento Packaging	
CONFEZIONI	N°Unità	BOX
10	50	500

Descrizione	Codice
Due valvole	ACH0104
Due valvole per farmaci fotosensibili	ACH0204
Quattro valvole	ACH0304
Quattro valvole per fotosensibili	ACH0404

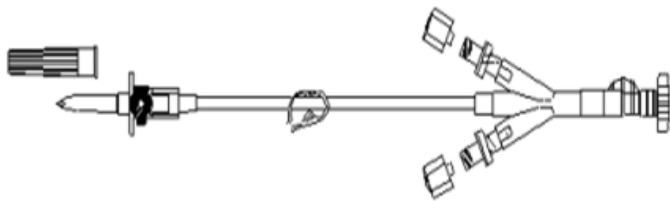

PE PVC DOP FREE ABS HDPE COPOLIMERO ACRILICO SILICONE

ACCESSO VASCOLARE NEEDLE FREE



	Confezionamento Packaging	
CONFEZIONI	N°Unità	BOX
10	50	500

Descrizione	Codice
Accesso vascolare needle free	ACH0101



PE COPOLIMERO ACRILICO SILICONE



Labelling Key



PERFORATORE PER CHEMIOTERAPICI



	Confezionamento Packaging	
CONFEZIONI	N°Unità	BOX
10	50	500

Descrizione	Codice
Perforatore una via	ACH0102

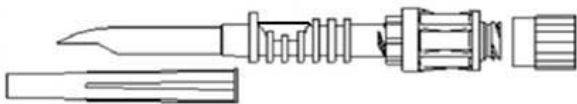

ABS PE COPOLIMERO ACRILICO SILICONE

PERFORSTORE PER CHEMIOTERAPICI



	Confezionamento Packaging	
CONFEZIONI	N°Unità	BOX
10	50	500

Descrizione	Codice
Perforatore due vie	ACH0103

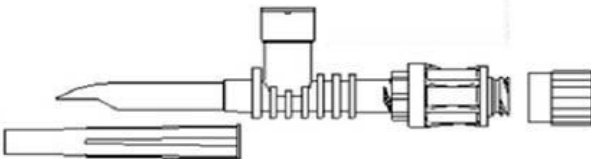

ABS PE COPOLIMERO ACRILICO SILICONE

Labelling Key



sicuri
di essere
sicuri

CE 0123

STERILE EO



Destroy after use



PROLUNGA CON RUBINETTO E RACCORDO NEEDLELESS



 Confezionamento
Packaging

CONFEZIONI	N°Unità	BOX
10	50	500

Descrizione	Codice
Prolunga con rubinetto con raccordo needle free	ACH0105
Prolunga con rubinetto con raccordo needle free per farmaci fotosensibili	ACH0106



ABS PP HDPE PE PVC DOP FREE COPOLIMERO ACRILICO SILICONE
MEMBRANA IDRO REPELENTE

PROLUNGA CON RAMPA E RACCORDO NEEDLELESS

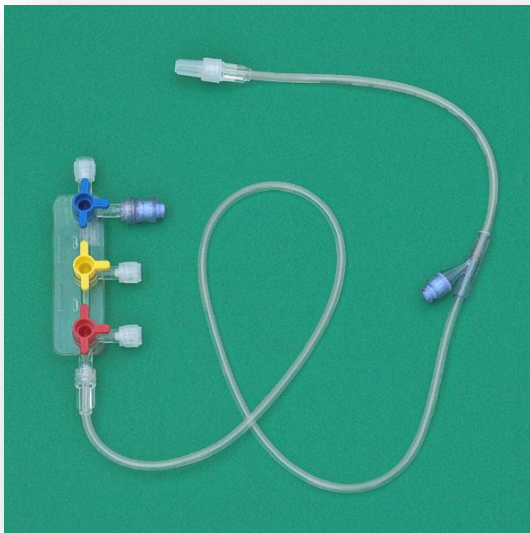

 Confezionamento
Packaging

CONFEZIONI	N°Unità	BOX
10	50	500





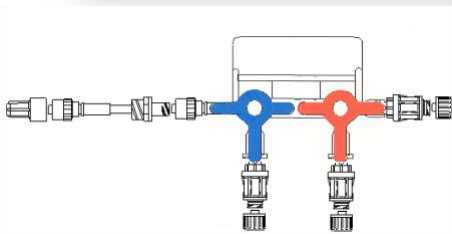







Descrizione	Codice
Prolunga con rampa 2 rubinetti	ACH0107
Prolunga con rampa 3 rubinetti	ACH0108
Prolunga con rampa 4 rubinetti	ACH0109
Prolunga con rampa 5 rubinetti	ACH0110
Prolunga con rampa 2 rubinetti per fotosensibili	ACH0111
Prolunga con rampa 3 rubinetti per fotosensibili	ACH0112
Prolunga con rampa 4 rubinetti per fotosensibili	ACH0113
Prolunga con rampa 5 rubinetti per fotosensibili	ACH0114



ABS PP HDPE PE PVC DOP FREE COPOLIMERO
ACRILICO SILICONE MEMBRANA IDRO
REPELENTE

Labelling Key

CE 0123 STERILE EO         Destroy after use

DISPOSITIVO PER INSTILLAZIONE ENDO VESCICALE DI FARMACI ANTIBLASTICI



 Confezionamento Packaging

CONFEZIONI	N°Unità	BOX
10	50	500

Descrizione	Codice
Con raccordo luer lock	CHD0301
Con raccordo cono gradini	CHD0302
Con raccordo luer lock per fotosensibili	CHD0311
Con raccordo cono gradini per fotosensibili	CHD0321

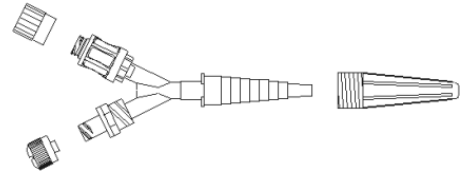
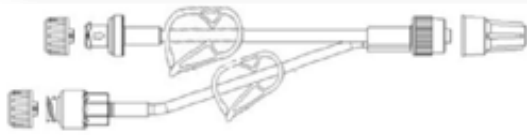

ABS PE HDPE PVC DOP FREE COPOLIMERO ACRILICO SILICONE MEMBRANA IDRO REPELENTE

PROLUNGHE



 Confezionamento Packaging

CONFEZIONI	N°Unità	BOX
10	50	500

Descrizione	Codice
Prolunga in PU Diametro 3x4.1 mm. Lunghezza 10 cm. Luer lock maschio femmina raccordo needleless	CHD0307
Prolunga in PU Diametro 3x4.1 mm. Lunghezza 10 cm. Luer lock maschio femmina raccordo needleless con filtro per taxolo 0.2 micron	CHD0308

Descrizione	Codice
Prolunga 2 vie tubo DEEP FREE Diametro 3x4.1mm Lunghezza 20 cm raccordi needleless	CHD0303
Prolunga 2 vie tubo DEEP FREE Diametro 1x2 mm Lunghezza 20 cm raccordi needleless	CHD0304
Prolunga 3 vie tubo DEEP FREE Diametro 3x4.1mm Lunghezza 20 cm raccordi needleless	CHD0305
Prolunga 3 vie tubo DEEP FREE Diametro 1x2 mm Lunghezza 20 cm raccordi needleless	CHD0306

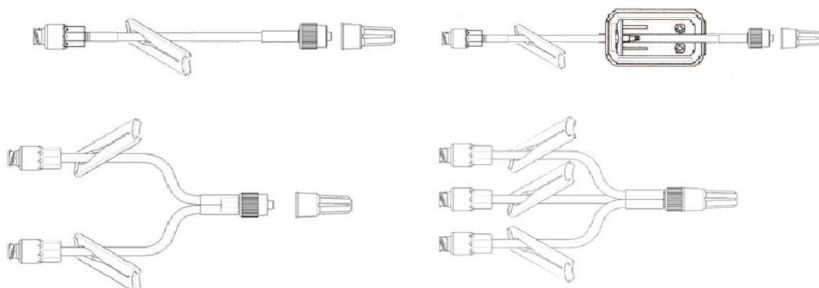

Labelling Key



Set per infusioni multiple in rianimazione, anestesia, chemioterapia

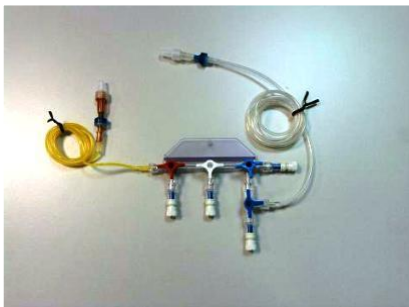

 Confezionamento Packaging		
CONFEZIONI	N°Unità	BOX
10	100	1000

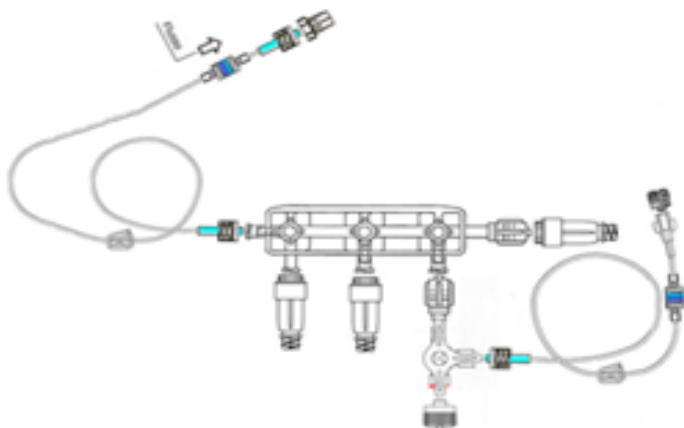

APC0105	Rampa 5 rubinetti 3 rubinetti 2 prolunghe 3x4.1 e 1.5x3
APC0103	Rampa 3 rubinetti 1 prolunga 1.5x3

ABS PE HDPE PVC DOP FREE COPOLIMERO ACRILICO SILICONE MEMBRANA IDRO REPELENTE

SET PER PREPARAZIONE CON VIA DI ACCESSO SECONDARIA



 Confezionamento Packaging		
CONFEZIONI	N°Unità	BOX
10	50	500



ABS PE HDPE PVC DOP FREE COPOLIMERO ACRILICO SILICONE MEMBRANA IDRO REPELENTE

Labelling Key



Descrizione	Codice
Valvola di non ritorno e needleless	CHD0101
Valvola di non ritorno e needleless per farmaci fotosensibili	CHD0102
Valvola di non ritorno e needleless filtro per taxani 0.2 micron	CHD0103
Valvola di non ritorno e needleless filtro per taxani 0.2 micrin per farmaci fotosensibili	CHD0104
Valvola di non ritorno e needleless regolatore di flusso 5/250 ml/h	CHD0105
Valvola di non ritorno e needleless regolatore di flusso 5/250 ml/h per farmaci fotosensibili	CHD0106

SET PER SOMMINISTRAZIONE CON VIE DI ACCESSO SECONDARIE





Confezionamento
Packaging

CONFEZIONI	N°Unità	BOX
10	20	200

Descrizione	Codice
Una valvola di connessione	CHD0201
Una valvola di connessione per fotosensibili	CHD0202
Due valvole di connessione	CHD0203
Due valvole di connessione per fotosensibili	CHD0204
Tre valvole di connessione	CHD0205
Tre valvole di connessione per fotosensibili	CHD0206
Quattro valvole di connessione	CHD0207
Quattro valvole di connessione per fotosensibili	CH02008



ABS PE HDPE PVC DOP FREE COPOLIMERO ACRILICO
SILICONE MEMBRANA IDRO REPELENTE PVC FREE

Descrizione	Codice
Due valvole di connessione per taxani filtro 0,2 micron	CHD0209
Quattro valvole di connessione per taxani filtro 0,2 micron	CHD0210
Due valvole di connessione con regolatore di flusso 5/250 ml/h	CHD0211
Due valvole di connessione con regolatore di flusso 5/250 ml/h fotosensibili	CHD0212
Quattro valvole di connessione con regolatore di flusso 5/250 ml/h	CHD0213
Quattro valvole di connessione con regolatore di flusso 5/250 ml/h fotosensibili	CHD0214

Descrizione	Codice
Due valvole di connessione con filtro per taxani 0,2 micron e regolatore di flusso 5/250 ml/h	CHD0215
Due valvole di connessione con filtro per taxani 0,2 micron e regolatore di flusso 5/250 ml/h per fotosensibili	CHD0216
Quattro valvole di connessione con filtro per taxani 0,2 micron e regolatore di flusso 5/250 ml/h	CHD0217
Quattro valvole di connessione con filtro per taxani 0,2 micron e regolatore di flusso 5/250 ml/h per fotosensibili	CHD0218

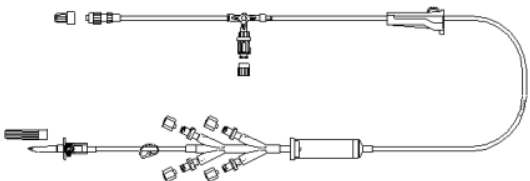

Labelling Key



CE 0123 STERILE EO

LAVEX

PVC

DOP

STERILIZE

Destroy after use

Oncology

GUANTI PER LA MANIPOLAZIONE DI FARMACI ANTIBLASTICI



	Confezionamento Packaging	
CONFEZIONI	N°Unità	BOX
1	50	50

Descrizione	Codice
Guanti	DPH0201

MISURE	6 7 8 9
SPESSORE	0.3 mm.
LUNGHEZZA	300 mm.



LATEX SENZA POLVERE

MASCHERINA PER LA MANIPOLAZIONE DI FARMACI ANTIBLASTICI

	Confezionamento Packaging	
CONFEZIONI	N°Unità	BOX
1	10	100

Descrizione	Codice
Mascherina	DPH0202



Labelling Key

















 Confezionamento Packaging		
CONFEZIONI	N°Unità	BOX
1	25	25

Descrizione	Codice
Tuta	DPH0203

TAGLIE
S M L X XL

A protezione chimica DPI di 3° categoria



Tessuto di polipropilene laminato con membrana traspirante impermeabile, cuciture termosaldate



Labelling Key



DRENAGGIO PERCUTANEO IN TORACENTESI



 Confezionamento Packaging		
CONFEZIONI	N°Unità	BOX
1	50	50

CARATTERISTICHE	CODICE
Triade aghi: 14 16 18 G 50/80 mm. Ago di Verres	THD0101 THA0102

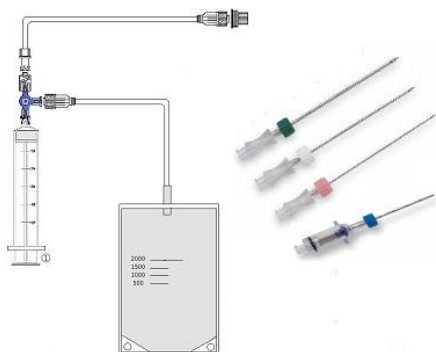

ABS PE PVC PP HDPE ACCIAIO INOX

DRENAGGIO PERCUTANEO IN PARACENTESI



 Confezionamento Packaging		
CONFEZIONI	N°Unità	BOX
1	50	50

CARATTERISTICHE	CODICE
Ago cannula 17 19 G Ago di Verres	TDH0201 TDH0202

ABS PE PVC PP HDPE ACCIAIO INOX

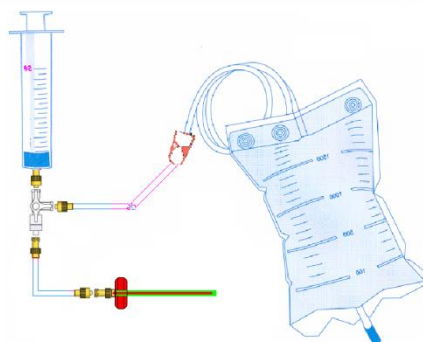

Labelling Key



SACCA PER DRENAGGIO STANDARD



 Confezionamento Packaging		
CONFEZIONI	N°Unità	BOX
1	250	250

CARATTERISTICHE	CODICE
Sacca 2 litri standard	NTU0101
Sacca 2 litri standard sterile	NTU0102

PE PVC HDPE

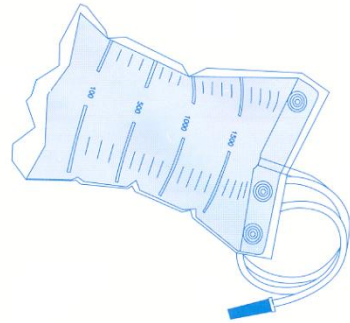

SACCA PER DRENAGGIO CON RUBINETTO



 Confezionamento Packaging		
CONFEZIONI	N°Unità	BOX
1	250	250

CARATTERISTICHE	CODICE
Sacca 2 litri rubinetto	NTU0105
Sacca 2 litri rubinetto sterile	NTU0106

PE PVC HDPE

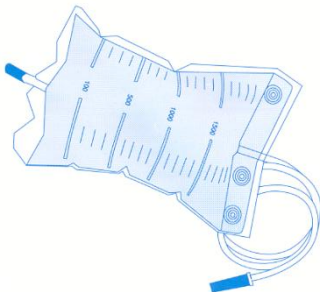

Labelling Key

CE 0123 STERILE EO

 Destroy after use







SACCA PER DRENAGGIO CON RUBINETTO A T



 Confezionamento Packaging		
CONFEZIONI	N°Unità	BOX
1	250	250

CARATTERISTICHE	CODICE
Sacca 2 litri rubinetto a T	NTU0103
Sacca 2 litri rubinetto a T sterile	NTU0104

PROLUNGA PER ASPIRAZIONE



 Confezionamento Packaging		
CONFEZIONI	N°Unità	BOX
6	10	60

DESCRIZIONE	CODICE
Connettore femmina femmina tubo 6.8mm.	SAD0001
Connettore maschio femmina tubo 6.8mm.	SAD0002
Connettore femmina femmina tubo 10 mm.	SAD0003
Prolunga tubo 6.8mm. con cannula Yankauer	SAD0004
Prolunga tubo 10 mm. con cannula Yankauer	SAD0005



PVC HDPE



Yankauer

PP

Labelling Key



**SET IRRIGAZIONE IN UROLOGIA CISTOGRAFIA
ARTROSCOPIA**





Confezionamento
Packaging

CONFEZIONI	N°Unità	BOX
6	10	60

DESCRIZIONE	CODICE
Urologia Cistoscopia 1 via connessione cono gradini	DDU0101
Urologia Cistoscopia 2 vie connessione cono gradini	DDU0102
Urologia Cistoscopia 2 vie connessione luer lock	DDU0103
Artroscopia 1 via connessione cono gradini	DDA0101
Artroscopia 2 vie connessione cono gradini	DDA0102
Artroscopia 2 vie connessione luer lock	DDA0103

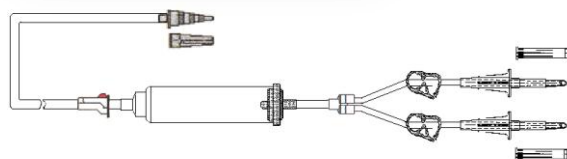

PVC PE ABS HDPE

PROLUNGHE LINEARI



Confezionamento
Packaging

CONFEZIONI	N°Unità	BOX
10	50	500

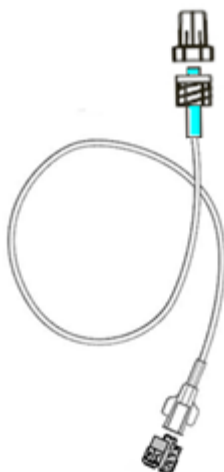

PVC PE ABS HDPE



TUBO IN PVC Diametro 3x4.1	
Descrizione	Codice
Tubo cm. 10	P014110
Tubo cm. 15	P014115
Tubo cm. 20	P014120
Tubo cm. 30	P014130
Tubo cm. 40	P014140
Tubo cm. 50	P014150
Tubo cm. 60	P014160
Tubo cm. 70	P014170
Tubo cm. 75	P014175
Tubo cm. 80	P014180
Tubo cm. 90	P014190
Tubo cm. 100	P0141100
Tubo cm. 120	P0141120
Tubo cm. 150	P0141150
Tubo cm. 180	P0141180
Tubo cm. 200	P0141200

Labelling Key

 0123
 

Destroy after use







PROLUNGHE LINEARI



Confezionamento
Packaging

CONFEZIONI	N°Unità	BOX
10	50	500

TUBO IN PVC Diametro 1.5	
Descrizione	Codice
Tubo cm. 10	P015310
Tubo cm. 25	P015325
Tubo cm. 50	P015350
Tubo cm. 90	P015390
Tubo cm. 100	P0153100
Tubo cm. 120	P0153120
Tubo cm. 150	P0153150
Tubo cm. 180	P0153180
Tubo cm. 200	P0153200
Tubo cm. 240	P0153240

PVC PE ABS HDPE

TUBO IN PVC 1X2	
DESCRIZIONE	CODICE
Tubo cm. 10	P011210
Tubo cm. 25	P011225
Tubo cm. 50	P011250
Tubo cm. 90	P011290
Tubo cm. 100	P0112100
Tubo cm. 120	P0112120
Tubo cm. 150	P0112150
Tubo cm. 180	P0112180
Tubo cm. 200	P0112200
Tubo cm. 240	P0112240

PROLUNGHE LINEARI PER FARMACI FOTOSENSIBILI



	Confezionamento Packaging	
CONFEZIONI	N°Unità	BOX
10	50	500

PVC PE ABS HDPE



TUBO AMBRATO 3X4.1	
DESCRIZIONE	CODICE
Tubo cm. 10	PF014110
Tubo cm. 15	PF014115
Tubo cm. 20	PF014120
Tubo cm. 30	PF014130
Tubo cm. 40	PF014140
Tubo cm. 50	PF014150
Tubo cm. 60	PF014160
Tubo cm. 70	PF014170
Tubo cm. 75	PF014175
Tubo cm. 80	PF014180
Tubo cm. 90	PF014190
Tubp cm. 100	PF0141100
Tubo cm. 120	PF0141120
Tubo cm. 150	PF0141150
Tubo cm. 180	PF0141180
Tubo cm. 200	PF0141200

TUBO AMBRATO 1X2	
DESCRIZIONE	CODICE
Tubo cm. 10	PF011210
Tubo cm. 25	PF011225
Tubo cm. 50	PF011250
Tubo cm. 90	PF011290
Tubo cm. 100	PF0112100
Tubo cm. 120	PF0112120
Tubo cm. 150	PF0112150
Tubo cm. 180	PF0112180
Tubo cm. 200	PF0112200
Tubo cm. 240	PF0112240

TUBO AMBRATO 1.5X3	
DESCRIZIONE	CODICE
Tubo cm. 10	PF015210
Tubo cm. 25	PF015325
Tubo cm. 50	PF015350
Tubo cm. 90	PF015390
Tubo cm. 100	PF0153100
Tubo cm. 120	PF0153120
Tubo cm. 150	PF0153150
Tubo cm. 180	PF0153180
Tubo cm. 200	PF0153200
Tubo cm. 240	PF0153240

Labelling Key



PROLUNGA CON RUBINETTO





Confezionamento
Packaging

CONFEZIONI	N°Unità	BOX
10	50	500

PVC PE ABS HDPE PP

Tubo in PVC Diam. 3x4.1	
DESCRIZIONE	CODICE
Tubo cm. 10	DVV0010
Tubo cm. 25	DVV0011
Tubo cm. 50	DVV0012
Tubo cm. 75	DVV0013
Tubo cm. 100	DVV0014
Tubo cm. 120	DVV0015

Tubo in PU Diam. 3x4.1	
DESCRIZIONE	CODICE
Tubo cm. 10	DVV0020
Tubo cm. 25	DVV0021
Tubo cm. 50	DVV0022
Tubo cm. 75	DVV0023
Tubo cm. 100	DVV0024
Tubo cm. 120	DVV0025

Tubo ambrato Dian 3x4.1	
DESCRIZIONE	CODICE
Tubo cm. 10	DVV0030
Tubo cm. 25	DVV0031
Tubo cm. 50	DVV0032
Tubo cm. 75	DVV0033
Tubo cm. 100	DVV0034
Tubo cm. 120	DVV0035



Confezionamento
Packaging

CONFEZIONI	N°Unità	BOX
10	50	500



PROLUNGA CON RAMPA



PVC PE ABS HDPE PP

DUE RUBINETTI	
DESCRIZIONE	CODICE
Tubo cm. 10	DVV0112
Tubo cm. 25	DVV0122
Tubo cm. 50	DVV0132
Tubo cm. 75	DVV0142
Tubo cm. 100	DVV0152
Tubo cm. 120	DVV0162

TRE RUBINETTI	
DESCRIZIONE	CODICE
Tubo cm. 10	DVV0113
Tubo cm. 25	DVV0123
Tubo cm. 50	DVV0133
Tubo cm. 75	DVV0143
Tubo cm. 100	DVV0153
Tubo cm. 120	DVV0163

QUATTRO RUBINETTI	
DESCRIZIONE	CODICE
Tubo cm. 10	DVV0114
Tubo cm. 25	DVV0124
Tubo cm. 50	DVV0134
Tubo cm. 75	DVV0144
Tubo cm. 100	DVV0154
Tubo cm. 120	DVV0164

CINQUE RUBINETTI	
DESCRIZIONE	CODICE
Tubo cm. 10	DVV0115
Tubo cm. 25	DVV0125
Tubo cm. 50	DVV0135
Tubo cm. 75	DVV0145
Tubo cm. 100	DVV0155
Tubo cm. 120	DVV0165

Labelling Key



Destroy
after use

PROLUNGA CON REGOLATORE DI FLUSSO

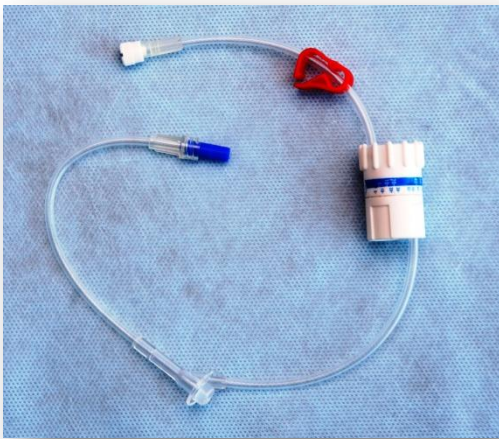

PVC PE ABS HDPE COPOLIMERO ACRILICO
SILICONE LATEX FREE



	Confezionamento Packaging	
CONFEZIONI	N°Unità	BOX
10	15	150

Descrizione	Codice
Standard	DVV0201
Per farmaci fotosensibili	DVV0202

PROLUNGA CON FILTRO ANTIBATTERICO



PVC PE ABS HDPE PTFE LATEX FREE



	Confezionamento Packaging	
CONFEZIONI	N°Unità	BOX
10	15	150

Descrizione	Codice
Standard	DVV0203
Per farmaci fotosensibili	DVV0204

Labelling Key

 0123    Destroy after use
     

PROLUNGA CON PIU' VIE DI SOMMINISTRAZIONE

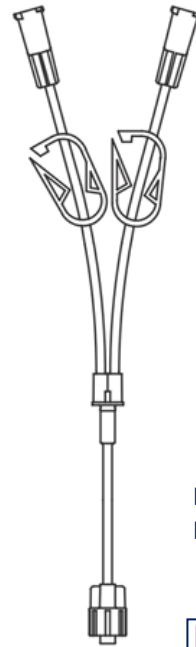
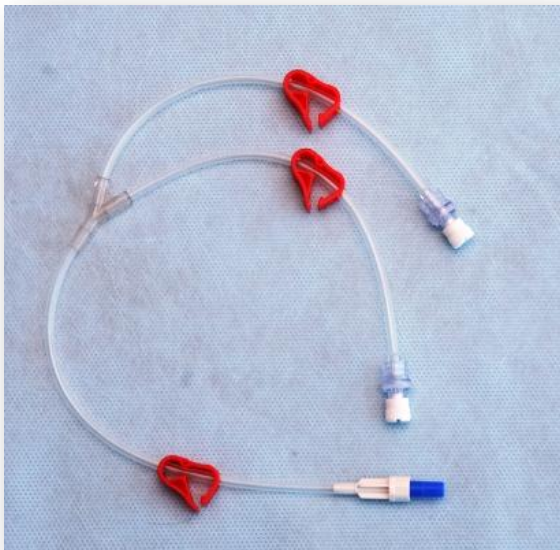



 Confezionamento Packaging

CONFEZIONI	N°Unità	BOX
10	15	150

PVC PE ABS HDPE ACRILICO LATEX FREE

Descrizione	Codice
Due vie	DVV2010
Tre vie	DVV3010
Quattro vie	DVV4010

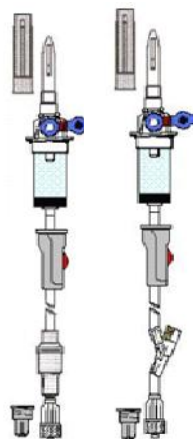
DISPOSITIVO PER INFUSIONE STANDARD



 Confezionamento Packaging

CONFEZIONI	N°Unità	BOX
20	25	500

PVC PE ABS HDPE MEMBRANA GELMAN LATEX FREE ACCIAIO INOX

Descrizione	Codice
Per sacca standard	DSP0101
Per sacca standard con ago	DSP0102
Per sacca con punto ago ad Y	DSP0103
Per sacca/fiacone standard	DSP0201
Per sacca/fiacone standard con ago	DSP0202
Per sacca/fiacone con punto ago ad Y	DSP0203
Per sacca /fiacone con microgoccia	DSP0204

Labelling Key

CE 0123 **STERILE EO**   Destroy after use
     

**DISPOSITIVO PER INFUSIONE PER FARMACI
FOTOSENSIBILI**

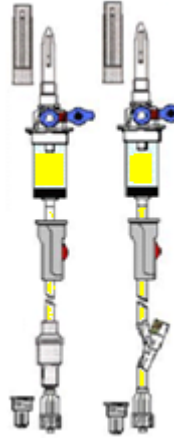
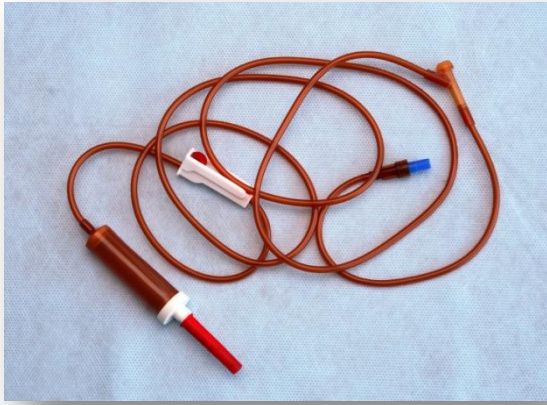

 Confezionamento Packaging		
CONFEZIONI	N°Unità	BOX
20	15	300

PVC PE ABS HDPE MEMBRANA
GELMAN LATEX FREE

Descrizione	Codice
Per sacca/fiacone standard	DSP0205
Per sacca/fiacone punto ago ad Y	DSP0206
Per sacca/fiacone con microgoccia	DSP0207

**DISPOSITIVO PER INFUSIONE CON BURETTA
GRADUATA**

 Confezionamento Packaging		
CONFEZIONI	N°Unità	BOX
1	50	50

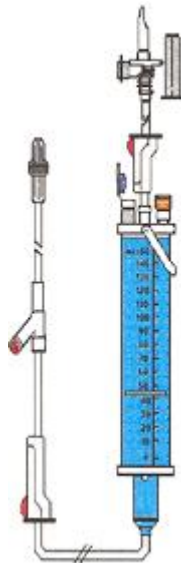

PVC PE ABS HDPE MEMBRANA
GELMAN LATEX FREE POLISULFONE



Descrizione	Codice
Per sacca/fiacone standard	DSP0208
Per trasfusione sangue	DSP0209
Per sacca/fiacone con microgoccia	DSP0210

Labelling Key



DISPOSITIVO PER SOMMINISTRAZIONE NUTRIZIONE ENTERALE

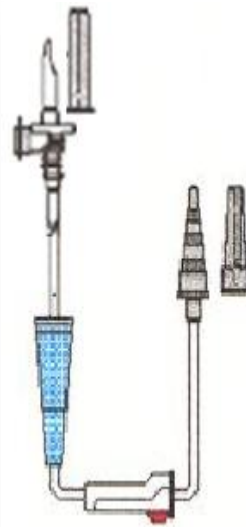
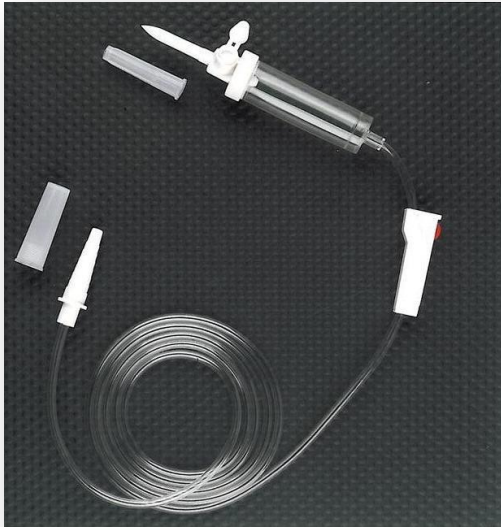

 Confezionamento Packaging		
CONFEZIONI	N°Unità	BOX
20	15	300

PVC PE ABS HDPE MEMBRANA GELMAN LATEX FREE

Descrizione	Codice
Per sacca	DSP0211

DISPOSITIVO PER INFUSIONE CON REGOLATORE DI FLUSSO



 Confezionamento Packaging		
CONFEZIONI	N°Unità	BOX
20	15	300

PVC PE ABS HDPE COPOLIMERO ACRILICO SILICONE LATEX FREE

Descrizione	Codice
Per sacca/flacone standard	DSP0212
Per farmaci fotosensibili	DSP0213
Per sacca/flacone con microgoccia	DSP0214

Labelling Key

CE 0123 STERILE EO



 Destroy after use





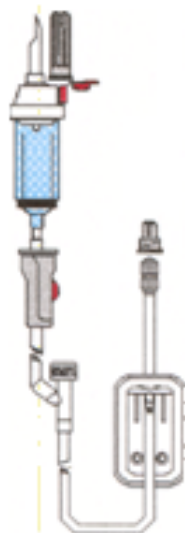
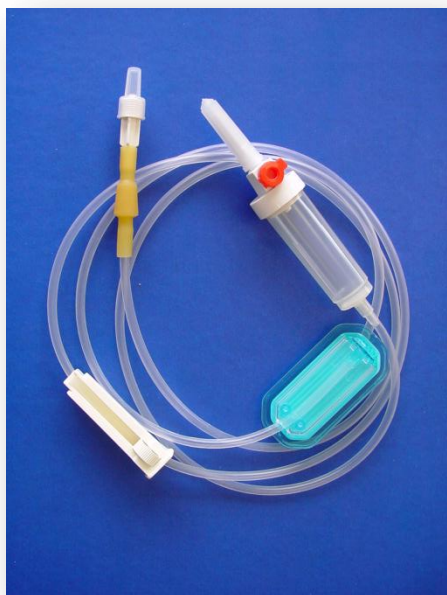

**DISPOSITIVO PER INFUSIONE CON FILTRO
ANTIBATTERICO 0.2 MICRON**



Confezionamento
Packaging

CONFEZIONI	N°Unità	BOX
20	15	300

PVC PE ABS HDPE PTFE
LATEX FREE

Descrizione	Codice
Per sacca/fiacone standard	DSP0215
Per farmaci fotosensibili	DSP0216
Per sacca/fiacone con microgoccia	DSP0217

DISPOSITIVO TRASFUSIONE SANGUE



Confezionamento
Packaging

CONFEZIONI	N°Unità	BOX
20	15	300

PVC PE ABS HDPE NYLON
LATEX FREE

Descrizione	Codice
Per sacca/fiacone standard	DSP0218
Con punto ago ad Y	DSP0219

Labelling Key

CE 0123 **STERILE EO** Destroy after use

**SACCA PER MISCELAZIONE E SOMMINISTRAZIONE
NUTRIZIONE PARENTERALE**



**Confezionamento
Packaging**

CONFEZIONI	N°Unità	BOX
1	50	50

EVA ABS LATEX FREE HDPT PVC
MEMBRANA GELMAN PE

Descrizione	Codice
150 ml. 1 via	NPT0101
150 ml. 2 vie	NPT0102
150 ml. 3 vie	NPT0103

Descrizione	Codice
250 ml.1 via	NPT0201
250 ml.2 vie	NPT0202
250 ml.3 vie	NPT0203

Descrizione	Codice
500 ml.1 via	NPT0301
500 ml.2 vie	NPT0302
500 ml.3 vie	NPT0303

Descrizione	Codice
1000 ml.1 via	NPT0401
1000 ml.2 vie	NPT0402
1000 ml.3 vie	NPT0403

Descrizione	Codice
2000 ml.1 via	NPT0501
2000 ml.2 vie	NPT0502
2000 ml.3 vie	NPT0503

Descrizione	Codice
3000 ml.1 via	NPT0601
3000 ml.2 vie	NPT0602
3000 ml.3 vie	NPT0603

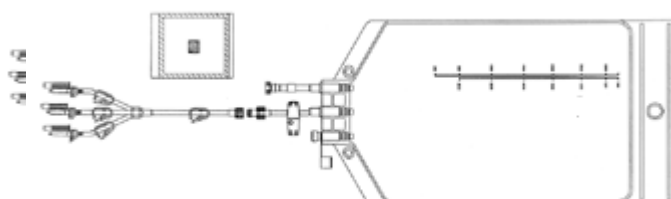
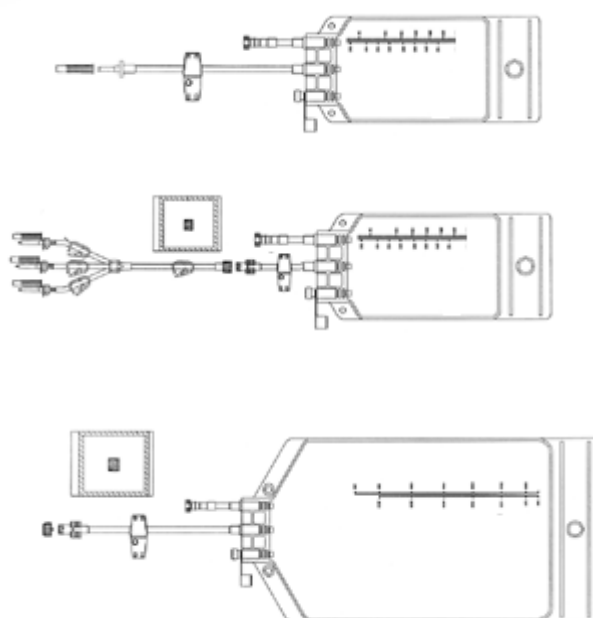

Labelling Key

CE 0123 **STERILE EO**   Destroy after use

**SACCA PER MISCELAZIONE E SOMMINISTRAZIONE
NUTRIZIONE ENTERALE**





Confezionamento
Packaging

CONFEZIONI	N°Unità	BOX
1	50	50

EVA ABS LATEX FREE HDPT PVC PE

Descrizione	Codice
500 ml.	NET0101
1000 ml.	NET0102
1500 ml.	NET0103
2000 ml.	NET0104

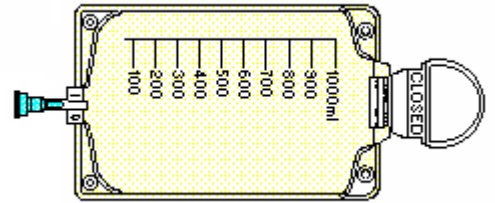

Descrizione	Codice
Con set somministrazione	
500 ml.	NET0201
1000 ml.	NET0202
1500 ml.	NET0203
2000 ml.	NET0204

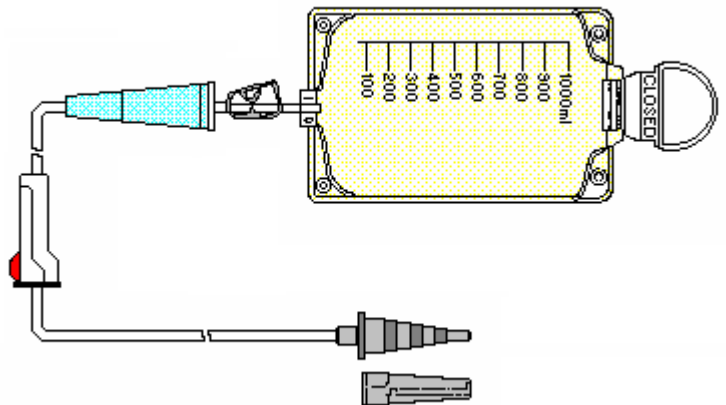

Labelling Key

CE 0123 STERILE EO

Destroy after use







**SACCA PER MISCELAZIONE E SOMMINISTRAZIONE
NUTRIZIONE PARENTERALE PER POMPA**





Confezionamento
Packaging

CONFEZIONI	N°Unità	BOX
1	50	50

EVA ABS LATEX FREE HDPT PVC PE

Descrizione	Codice
150 MI.	NPP0101
250 MI.	NPP0102
500 MI.	NPP0103
1000 MI.	NPP0104
2000 MI.	NPP0105
3000 MI.	NPP0106

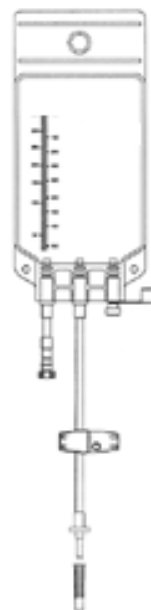

Labelling Key

CE 0123 STERILE EO

Destroy
after use







**SACCA PEDIATRICA PER MISCELAZIONE E
SOMMINISTRAZIONE NUTRIZIONE PARENTERALE**





Confezionamento
Packaging

CONFEZIONI	N°Unità	BOX
1	50	50

EVA ABS LATEX FREE HDPT PVC PE

Descrizione	Codice
250 ml. 3 vie	NPP0103
500 ml. 3 vie	NPP0303

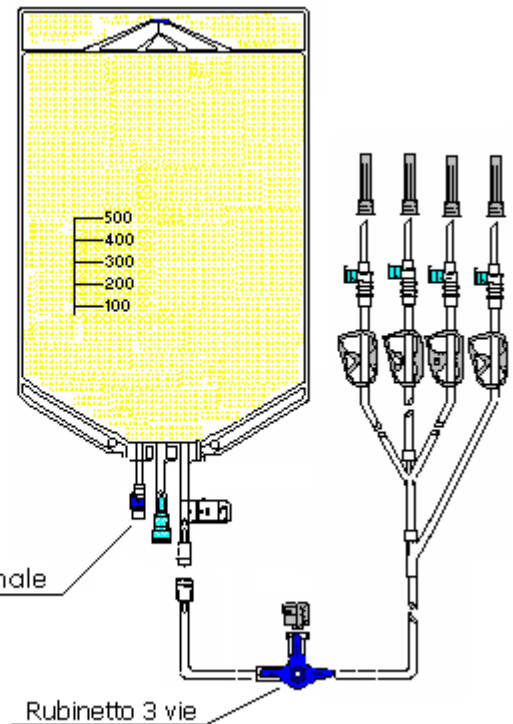

Labelling Key

CE 0123 STERILE EO



Destroy after use





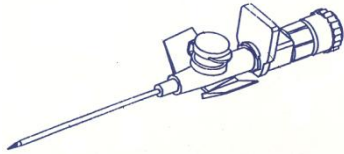

AGO CANNULA CON VALVOLA INIEZIONE



PTFE



Confezionamento
Packaging

CONFEZIONI	N°Unità	BOX
10	100	1000

Calibro G	Colore	Diametri Int. Est. in mm.	Lunghezza in cm.	Flusso ml/min.
14	Arancio	1.6 2.1	45	270
16	Grigio	1.3 1.7	45	180
17	Bianco	1.2 1.5	45	120
18	Verde	0.9 1.3	45	90
20	Rosa	0.8 1.1	32	60
22	Blu	0.6 0.9	25	36
24	Giallo	0.5 0.7	19	20
26	Viola	0.4 0.6	19	13

AGO CANNULA SENZA VALVOLA INIEZIONE

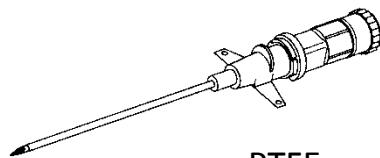

PTFE



Confezionamento
Packaging

CONFEZIONI	N°Unità	BOX
10	100	1000

Calibro G	Colore	Diametri Int. Est. in mm.	Lunghezza in cm.	Flusso ml/min.
14	Arancio	1.6 2.1	45	270
16	Grigio	1.3 1.7	45	180
17	Bianco	1.2 1.5	45	120
18	Verde	0.9 1.3	45	90
20	Rosa	0.8 1.1	32	60
22	Blu	0.6 0.9	25	36
24	Giallo	0.5 0.7	19	20
26	Viola	0.4 0.6	19	13

Labelling Key









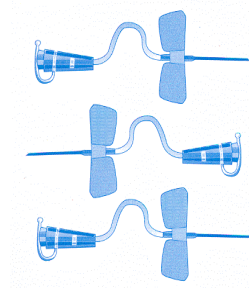

SET EPICRANICO – SCALP VEIN



 Confezionamento Packaging		
CONFEZIONI	N°Unità	BOX
1	100	2000

PE ABS HDPT PVC LATEX FREE ACCIAIO INOX



Ago	Colore
18G - 1,2x19 mm	
19G - 1,1x19 mm	
20G - 0,9x19 mm	
21G - 0,8x19 mm	
22G - 0,7x19 mm	
23G - 0,6x19 mm	
25G - 0,5x19 mm	
27G - 0,4x19 mm	

Descrizione	Codice
AGO 18G	SVS0101
AGO 19G	SVS0102
AGO 20G	SVS0103
AGO 21G	SVS0104
AGO 22G	SVS0105
AGO 23G	SVS0106
AGO 25G	SVG 0107
AGO 27G	SVG 0108

Labelling Key

 0123    Destroy after use
     

CATETERE FOLEY





Confezionamento
Packaging

CONFEZIONI	N°Unità	BOX
1	10	100

LATTICE SILICONATO

MISURE DEL DISPOSITIVO				
DIAMETRO	LUNGHEZZA	PUNTA	PALLONCINO	
CH 10	30	NELATON	3	ml.
CH 14	25	NELATON	5-10	ml.
CH 16 18	25	NELATON	5-15	ml.
CH 12 14	40	NELATON	5-10	ml.
CH 16 18 20 22 24	40	NELATON	5-15	ml.
CH 12 14	40	NELATON	30	ml.
CH 16 18 20	40	NELATON	30-50	ml.
CH 12 14 16 18 20	40	TIEMANN	5-15	ml.
CH 12 14 16 18 20 22 24 26	40	NELATON	5-15	ml.
TRE VIE				
CH 18 20 22 24	40	NELATON	5-15	ml.

SILICONE

MISURE DEL DISPOSITIVO			
DIAMETRO	LUNGHEZZA	PUNTA	PALLONCINO
CH 6	31	NELATON	1.5 ml.
CH 8	31	NELATON	3 ml.
CH 10	31	NELATON	3-5 ml.
CH 12 14	41	NELATON	5-10 ml.
CH 16 18 20 22 24	41	NELATON	5-15 ml.
CH 18 20	41	NELATON	20 ml.
CH 22 24	41	NELATON	30 ml.
CH 12 14	41	TIEMANN	5-10 ml.
CH 16 18 20 22 24	41	TIEMANN	5-15 ml.
CH 12 14	41	NELATON	5-10 ml.
CH 16 18 20 22 24	41	NELATON	5-15 ml.

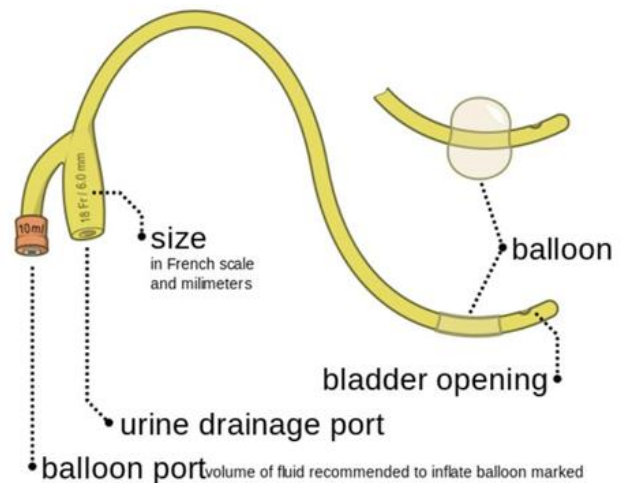

Labelling Key

CE 0123 STERILE EO   Destroy after use

Medical grade PVC, hydrophilic coating.

Foley

CATETERE NELATON



 Confezionamento Packaging		
CONFEZIONI	N°Unità	BOX
1	10	100

CATETERE NELATON UOMO

FG		
6	Verde Chiaro	
8	Blu	
10	Nero	
12	Bianco	
14	Verde	
16	Arancione	
18	Rosso	
20	Giallo	
22	Viola	
24	Blu Chiaro	

cm.40

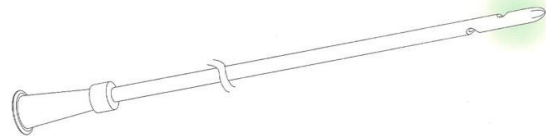

Medical grade PVC, hydrophilic coating.



CATETERE NELATON DONNA

FG		
6	Verde Chiaro	
8	Blu	
10	Nero	
12	Bianco	
14	Verde	
16	Arancione	
18	Rosso	
20	Giallo	

cm.18

Labelling Key





 Destroy after use







KIT PER MEDICAZIONE STERILE



	Confezionamento Packaging	
CONFEZIONI	N°Unità	BOX
1	10	100

Kit sterile per medicazione composto da:
1 pinzetta zigrinata monouso
3 tamponi diametro cm 3
2 compresse di cotone 8/16 strati cm 5x10
1 telo in TNT + PE cm 50x40
Confezione singola sterile in blister.

GARZA IN COTONE STERILE



	Confezionamento Packaging	
CONFEZIONI	N°Unità	BOX
1	10	100

Garze realizzate in puro cotone idrofilo piegate
Disponibili in versione 8 oppure 16 strati 10X20
Senza filo radiopaco
Sterili
Busta da 10 garze sterili

Labelling Key



Mediflex

OCCHIALINO PER OSSIGENO TERAPIA



 Confezionamento Packaging		
CONFEZIONI	N°Unità	BOX
1	80	80

Descrizione	Codice
Occhialino	OND0101

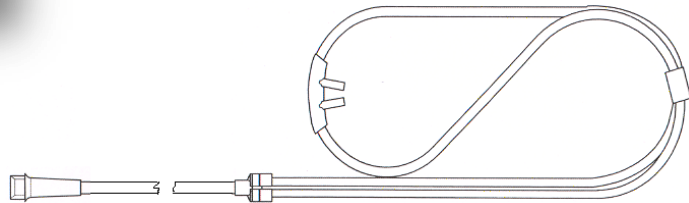

PE HDPT PVC LATEX FREE

PROLUNGA PER OSSIGENO TERAPIA



 Confezionamento Packaging		
CONFEZIONI	N°Unità	BOX
1	50	50



PE HDPT PVC LATEX FREE

Descrizione	Codice
Prolunga 3 m.	OND0103
Prolunga 5 m.	OND0105
Prolunga 9 m.	OND0109

Labelling Key

